

Owner's Manual

Model

BF45DXP

BF39STP/DXP

BF33STP/DXP









IMPORTANT SAFETY INFORMATION: Always read this manual first before attempting to install or use this fireplace. For your safety, always comply with all warnings and safety instructions contained in this manual to prevent personal injury or property damage.

To view the full line of Dimplex products, please visit www.dimplex.com

7206360500R06





Table of Contents

| | |
|--|----|
|  Welcome & Congratulations | 3 |
|  IMPORTANT INSTRUCTIONS | 4 |
|  Fireplace Installation | 5 |
|  Operation | 6 |
|  Maintenance | 8 |
|  Accessories | 10 |
|  Warranty | 11 |
|  Technical Support | 13 |

Always use a qualified technician or service agency to repair this fireplace.

! NOTE: Procedures and techniques that are considered important enough to emphasize.

 **CAUTION:** Procedures and techniques which, if not carefully followed, will result in damage to the equipment.

 **WARNING:** Procedures and techniques which, if not carefully followed, will expose the user to the risk of fire, serious injury, or death.

Welcome & Congratulations

Thank you and congratulations for purchasing an electric fireplace from Dimplex. Please use our convenient online registration page to record your model and serial numbers for future reference at

www.dimplex.com/register

Model Number _____ **Serial Number** _____

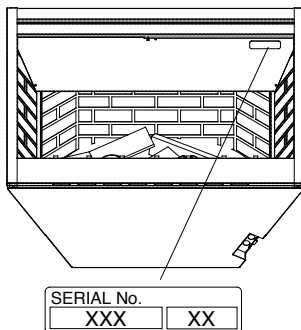
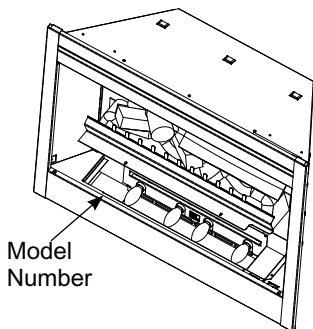

Please carefully read and save these instructions.

⚠ CAUTION: Read all instructions and warnings carefully before starting installation. Failure to follow these instructions may result in a possible electric shock, fire hazard and will void the warranty.



NO NEED TO RETURN TO THE STORE

Questions with operation or assembly? Require Parts Information?
Product Under Manufacturer's Warranty?

Contact us at:  **www.dimplex.com/customer_support**
For Troubleshooting and Technical Support

OR  **Toll-Free 1-888-DIMPLEX (1-888-346-7539)**
Monday to Friday 8:00 a.m. to 4:30 p.m. EST

In order to better serve you, please have your model and serial number ready or register your product online before calling (See above)

IMPORTANT INSTRUCTIONS

When using electrical appliances, basic precautions should always be followed to reduce the risk of fire, electric shock, and injury to persons, including the following:

- ① Read all instructions before using this appliance.
- ② This fireplace is hot when in use. To avoid burns, do not let bare skin touch hot surfaces. The trim around the heater outlet becomes hot during heater operation. Keep combustible materials, such as furniture, pillows, bedding, papers, clothes, and curtains at least 3 feet (0.9m) from the front of the unit.
- ③ Extreme caution is necessary when any heater is used by or near children or invalids and whenever the fireplace is left operating and unattended.
- ④ Do not operate any heater after it malfunctions. Disconnect power at the service panel and have the heater inspected by a reputable electrician before reusing.
- ⑤ Do not operate any unit with a damaged cord or plug, or if the heater has malfunctioned, or if the electric fireplace has been dropped or damaged in any manner, contact Dimplex Technical Service at 1-888-346-7539.
- ⑥ Never locate this heater where it may fall into a bathtub or other water container.
- ⑦ Do not use outdoors.
- ⑧ Do not insert or allow foreign objects to enter any ventilation or exhaust opening as this may cause an electric shock or fire, or damage to the heater.
- ⑨ To prevent a possible fire, do not block air intake or exhaust in any manner.
- ⑩ All electrical heaters have hot and arcing or sparking parts inside. Do not use in areas where gasoline, paint, or flammable liquids are used or stored
- ⑪ Do not modify this fireplace.



CAUTION
RISK OF ELECTRIC SHOCK
DO NOT OPEN
NO USER-SERVICEABLE PARTS INSIDE



SAVE THESE INSTRUCTIONS

IMPORTANT INSTRUCTIONS

Use it only as described in this manual. Any other use not recommended by the manufacturer may cause fire, electric shock or injury to persons.

- ⑫ Do not burn wood or other materials in this fireplace.
- ⑬ Do not strike fireplace glass.
- ⑭ Always use a certified electrician for installation.
- ⑮ Disconnect all power coming to fireplace at main service panel before performing any cleaning, or maintenance.

⑯ When transporting or storing the fireplace, keep in a dry place, free from excessive vibration and store as to avoid damage.

! NOTE: Changes or modifications not expressly approved by the party responsible for compliance could void user's authority to operate the equipment.

Fireplace Installation

Bathroom Installation

This firebox must be protected by a GFI circuit. If a receptacle is used it must be readily accessible.

To prevent electrical shock this unit is an electrical appliance that is not watertight and must be installed as to prevent water from entering the unit. This unit must be installed away from showers, tubs, etc. Never locate fireplace where it may fall into a bathtub or other water containers. Keep towels and other combustible

materials 3 feet (0.9 m) away from the front of the unit.

Operation

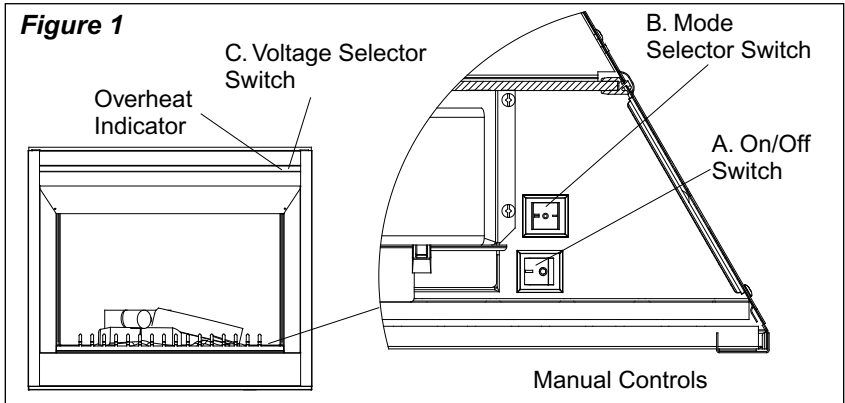

⚠ WARNING: This electric firebox must be properly installed before it is used.

Manual Controls

(Figure 1)

The controls for the Electric Fireplace are located at the bottom right hand corner of the unit.

⚠ CAUTION: Ensure that the Voltage Selector switch is set to the appropriate voltage (115V or 230V)

A. On/Off Switch

The on/off switch energizes the firebox and flame.

B. Mode Selector Switch

Select preferred feature:

- “o” for flame only
- “-” for fan only/flame
- “=” for heat/flame

! NOTE: The heater may emit a slight, harmless odor when first used. This odor is a normal condition caused by initial heating of internal heater parts and will not occur again.

C. Voltage Selector Switch

Needs to be set to reflect the incoming voltage to the unit - 115V or 230V.

Resetting The Temperature Cutoff Switch

The heater on this fireplace is protected with a safety device to prevent overheating. Should the heater overheat, the Overheat indicator will be activated (Fig. 1), and an automatic cutout will turn the heater off and it will not come back on without being reset. It can be reset by switching

Operation

the On/Off switch to OFF and waiting 5 minutes before switching it to ON. The overheat cutout will be triggered if the filter is dirty. Follow filter maintenance.

⚠ CAUTION: If you need to continuously reset the heater, disconnect power and call Dimplex customer service at (1-888-346-7539).

Remote Controls

An optional remote control can be purchased to operate the fireplace - BFRC-KIT. This will allow the user the ability to toggle through the stages of operation: Flames, Flames/Fan, and Flames/Heat, with a remote control.

Wall Mounted Controls

The fireplace can be installed with wall mounted controls. These controls include wall switches and thermostats. (see individual installation guides for details)

1. Wall Mounted Switches

This model may be installed so that a wall mounted switch energizes the firebox and flame, **(On/Off Switch must be in the ON position)**. A wall mounted switch may also be used to override the flame

image, **(On/Off Switch must be in the ON position in coordination with any main power wall mounted switch)**. A wall mounted switch may also be used to override the heater option **(Mode Selector Switch must be in the “=” position)**.

2. Wall Mounted Thermostat

This unit may be installed so that a wall mounted thermostat can adjust the heat temperature to your individual requirements. Please refer to thermostat manufacturers operation Instructions. **Mode Selector Switch must be set to “=” for thermostat to control heater/.**

3. Wall Mounted Remote Controls (WRCPF-KIT)

Dimplex manufactures a optional wall mounted remote control which allows the user to fully control the fireplace from a central location with the added functionality of a built in thermostat.



Maintenance

⚠ WARNING: Disconnect power and heater has cooled before attempting any maintenance or cleaning to reduce the risk of fire, electric shock or damage to persons.

! NOTE: The fireplace should not be operated with an accumulation of dust or dirt on or in the unit, as this can cause a build up of heat and eventual damage. For this reason the heater must be inspected regularly, depending upon conditions and at least at yearly intervals.

Light Bulb Replacement

Light bulbs need to be replaced when you notice a dark section of the flame or when the clarity and detail of the log exterior disappears. There are four bulbs under the log set which generate the flames and embers.

Helpful Hints: It is a good idea to replace all light bulbs at one time if they are close to the end of their rated life. Group replacement will reduce the number of times you need to open the unit to replace light bulbs. Long life bulbs are recommended to reduce the frequency of bulb changes.

Light Bulb Requirements:

Quantity of 4 clear chandelier or candelabra bulbs with an E-12 (small) socket base, 60 Watt rating. Example: GE 60BC or Philips 60CTC. **DO NOT EXCEED 60 WATTS PER BULB.**

⚠ CAUTION: When handling log only apply force to the ember bed section not directly to the logs.

To access the light bulb area

⚠ CAUTION: Allow at least 5 minutes for light bulbs to cool off before touching bulbs to avoid accidental burning of skin.

1. Open steel curtain (remove glass doors if applicable).
2. Remove two screws on log bracket and set aside (Figure 2)
3. Pull front edge of plastic ember bed or plastic grate up and forward until rear tab releases from the ledge

Figure 2

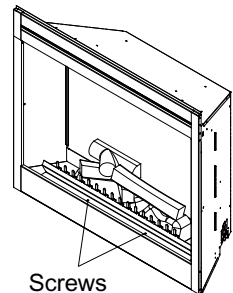



Maintenance

Figure 3

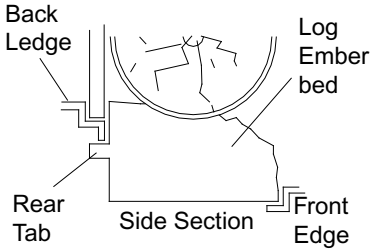
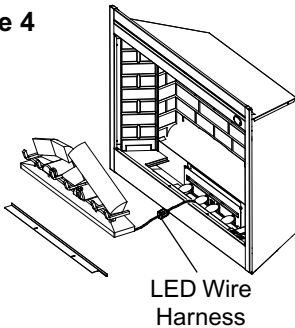

Figure 4



located at the bottom of the partially reflective glass (Figure 3).

- ! NOTE:** Log set fits tightly into firebox, some force may be necessary to remove.
4. Set logset in front of firebox.
 5. Disconnect the logset LED wire harness from unit (Figure 4).
 6. Examine the bulbs to determine which bulbs require replacement.

7. Unscrew bulbs counter clockwise.
8. Insert new bulbs.
9. Re-connect the logset LED wire harness to the unit.
10. Replace the log by inserting the rear tab of the logset under the back ledge of the fireplace and push down on the front edge of the logset until it snaps into place (Figure 3).
11. Replace log grate using two screws previously removed.



Maintenance

Partially Reflective Glass Cleaning

The partially reflective glass is cleaned in the factory during the assembly operation. During shipment, installation, handling, etc., the partially reflective glass surface may collect dust particles. These can be removed by buffing lightly with a clean dry cloth.

To remove fingerprints or other marks, the partially reflective glass can be cleaned with a damp cloth using high quality household glass cleaner. The partially reflective glass should be completely dried with a lint free cloth. To prevent scratching, do not use abrasive cleaners or spray liquids on any surface.

Fireplace Surface Cleaning

Use warm water only to clean painted surfaces of the Compact Fireplace. Do not use abrasive cleaners.

Servicing

Except for light bulb replacement and cleaning described above, an authorized service representative should perform any other servicing.



Accessories

Please contact your local dealer for genuine Dimplex accessories. Example: glass door kits, brass and stainless steel trims, remote control kits, plug kits, and cabinets designed to fit your fireplace.



Warranty

Two Year Limited Warranty

Products to which this limited warranty applies

This limited warranty applies to the following models of your newly purchased Dimplex electric fireplace **BF45DXP**, **BF39DXP**, **BF39STP**, **BF33DXP**, **BF33STP** and to newly purchased Dimplex fireplace surrounds (mantels) and trims. This limited warranty applies only to purchases made in any province of Canada *except* for Yukon Territory, Nunavut, or Northwest Territories or in any of the 50 States of the USA (and the District of Columbia) *except* for Hawaii and Alaska. This limited warranty applies to the original purchaser of the product only and is not transferable.

Products excluded from this limited warranty

Light bulbs are not covered by this limited warranty and are the sole responsibility of the owner/purchaser. Products purchased in Yukon Territory, Nunavut, Northwest Territories, Hawaii, or Alaska are not covered by this limited warranty. Products purchased in these States, provinces, or territories are sold AS IS without warranty or condition of any kind (including, without limitation, any implied warranties or conditions of merchantability or fitness for a particular purpose) and the entire risk of as to the quality and performance of the products is with the purchaser, and in the event of a defect the purchaser assumes the entire cost of all necessary servicing or repair.

What this limited warranty covers and for how long

Products, other than fireplace surrounds (mantels) and trims, covered by this limited warranty have been tested and inspected prior to shipment and, subject to the provisions of this warranty, Dimplex warrants such products to be free from

defects in material and workmanship for a period of 2 years from the date of the first purchase of such products.

Dimplex fireplace surrounds (mantels) and trims covered by this limited warranty have been tested and inspected prior to shipment and, subject to the provisions of this warranty, Dimplex warrants such products to be free from defects in material and workmanship for a period of 1 year from the date of first purchase of such products.

The limited 2 year warranty period for products other than fireplace surrounds (mantels) and trims and the limited 1 year warranty period for fireplace surrounds (mantels) and trims also applies to any implied warranties that may exist under applicable law. Some jurisdictions do not allow limitations on how long an implied warranty lasts, so the above limitation may not apply to the purchaser.

What this limited warranty does not cover

This limited warranty does not apply to products that have been repaired (except by Dimplex or its authorized service representatives) or otherwise altered. This limited warranty does further not apply to defects resulting from misuse, abuse, accident, neglect, incorrect installation, improper maintenance or handling, or operation with an incorrect power source.

What you must do to get service under this limited warranty

Defects must be brought to the attention of Dimplex Technical Service by contacting Dimplex at 1-888-DIMPLEX (1-888-346-7539), or 1367 Industrial Road, Cambridge Ontario, Canada N3H 4W3. Please have proof of purchase, catalogue/model and serial numbers available when calling. Limited warranty service requires a proof of purchase of the product.

Warranty

What Dimplex will do in the event of a defect

In the event a product or part covered by this limited warranty is proven to be defective in material or workmanship during (i) the 2 year limited warranty period for products other than fireplace surrounds (mantels) and trims, and (ii) the 1 year limited warranty period for surrounds (mantels) and trims, you have the following rights:

- Dimplex will in its sole discretion either repair or replace such defective product or part without charge. If Dimplex is unable to repair or replace such product or part, or if repair or replacement is not commercially practicable or cannot be timely made, Dimplex may, in lieu of repair or replacement, choose to refund the purchase price for such product or part.
- Limited warranty service will be performed solely by dealers or service agents of Dimplex authorized to provide limited warranty services.
- **For products other than surrounds (mantels) and trims**, this 2 year limited warranty entitles the purchaser to on-site or in-home warranty services. Accordingly, Dimplex will be responsible for all labour and transportation associated with repairing or replacing the product or part except as follows: (i) charges which may be levied for travel costs incurred to travel to the purchaser's site where the product is located if the purchaser's site is beyond 30 miles (48 km) from the closest service depot of Dimplex's dealer or service agent; and (ii) the purchaser is solely responsible for providing clear access to all serviceable parts of the product.

- **For surrounds (mantels) and trims**, this 1 year limited warranty does not entitle the purchaser to on-site or in-home warranty services. The purchaser is responsible for removal and transportation of the surrounds (mantels) and trims (and any repaired or replacement product or part) to and from the authorized dealer's or service agent's place of business. On-site or in-home services for surrounds (mantels) and trims may be performed at the purchaser's specific request and expense at Dimplex's then-current rates for such services. Dimplex will not be responsible for, and this limited warranty shall not include, any expense incurred for installation or removal of the surrounds (mantels) or trims or any part thereof (or any replacement product or part) including, without limitation, all shipping costs and transportation costs to and from the authorized dealer's or service agent's place of business and all labour costs. Such costs shall be the purchaser's responsibility.

What Dimplex and its dealers and service agents are also not responsible for:

IN NO EVENT WILL DIMPLEX, OR ITS DIRECTORS, OFFICERS, OR AGENTS, BE LIABLE [TO THE PURCHASER OR ANY THIRD PARTY](#), WHETHER IN CONTRACT, IN TORT, OR ON ANY OTHER BASIS, FOR ANY INDIRECT, SPECIAL, PUNITIVE, EXEMPLARY, CONSEQUENTIAL, OR INCIDENTAL LOSS, COST, OR DAMAGE ARISING OUT OF OR IN CONNECTION WITH THE SALE, MAINTENANCE, USE, OR INABILITY TO USE THE PRODUCT, EVEN IF DIMPLEX OR ITS DIRECTORS, OFFICERS, OR AGENTS HAVE BEEN ADVISED OF THE POSSIBILITY OF SUCH LOSSES, COSTS OR DAMAGES, OR IF SUCH LOSSES, COSTS, OR

Warranty

DAMAGES ARE FORESEEABLE. IN NO EVENT WILL DIMPLEX, OR ITS OFFICERS, DIRECTORS, OR AGENTS BE LIABLE FOR ANY DIRECT LOSSES, COSTS, OR DAMAGES THAT EXCEED THE PURCHASE PRICE OF THE PRODUCT.

SOME JURISDICTIONS DO NOT ALLOW THE EXCLUSION OR LIMITATION OF INCIDENTAL OR CONSEQUENTIAL DAMAGES, SO THE ABOVE LIMITATION OR EXCLUSION MAY NOT APPLY TO THE PURCHASER.

How State and Provincial law apply

This limited warranty gives you specific legal rights, and you may also have other rights which vary from jurisdiction to jurisdiction. The provisions of the United Nations Convention on Contracts for the Sale of Goods shall not apply to this limited warranty or the sale of products covered by this limited warranty.

Technical Support

Technical and troubleshooting support, as well as a list of replacement parts can be found on

www.dimplex.com/customer_support.

Dimplex[®]

Dimplex North America Limited

1367 Industrial Road
Cambridge ON
Canada N3H 4W3

© 2017 Dimplex North America Limited